



## 1. DESCRIPTION

Periodical defrost may be performed with **MT-512e 2HP** by stopping the compressor (natural defrost) and forcing defrost manually. It is provided with a powerful 16A relay for actuating loads of up to 2HP, in addition to a command output combined with a timer for programming refrigeration and defrosting times. Another feature available is the turning off of the control functions, making the **MT-512e 2HP** operate only as a temperature indicator. It is also provided with a configurable digital filter, which has the purpose of simulating mass increase in the environment sensor, thus increasing its response time, i.e., it renders the sensor response slower (delay). Through an intelligent function blocking system, it prevents unauthorized personnel from changing the control parameters.

**MT-512e 2HP** can also be set for heating.  
Product conforming to UL Inc. (United States and Canada) and NSF (United States).

## 2. SAFETY RECOMMENDATIONS

- Check the controller for correct fastening;
- Make sure that the power supply is off and that it is not turned on during the controller installation;
- Read the present manual before installing and using the controller;
- Use adequate Personal Protective Equipment (PPE);
- For application at sites subject to water spills, such as refrigerated counters, install the protecting vinyl supplied with the controller;
- For protection under more critical conditions, we recommend the Ecase cover, which we make available as an optional item (sold separately);
- The installation procedures should be performed by a qualified technician.

## 3. APPLICATIONS

- Cold storages
- Reach-In Coolers / Stand Up Coolers
- Industrial heating / Cooling equipment
- Any other type of equipment requiring precise temperature control

## 4. TECHNICAL SPECIFICATIONS

Power supply	MT-512E 2HP: 115 or 230 Vac $\pm 10\%$ * (50/60 Hz) MT-512EL 2HP: 12 or 24 Vdc or Vac $\pm 10\%$ *
Control temperature (**)	- 50 to 105°C (-58 to 221°F)
Operating temperature	0 to 50°C / 32 to 122°F
Operating humidity	10 to 90% RH (without condensation)
Resolution	0.1°C
Maximum load current (***)	16 A for resistive-type loads and 12 A for inductive-type loads
Maximum load power (***)	2HP
Protection level	IP 65 (frontal)
Dimensions (mm)	76 x 34 x 77 mm (Width x Height x Depth)
Cutout dimensions (mm)	X = 71 $\pm 0,5$ Y = 29 $\pm 0,5$ (see image V)

(\*) Admissible variation in relation to the voltage rating.  
(\*\*) This instrument measures and controls temperatures of up to 200°C/392°F, using the silicone sensor cable SB59 (sold separately).  
(\*\*\*) For higher loads, use contactor.

## 5. INDICATIONS AND KEYS

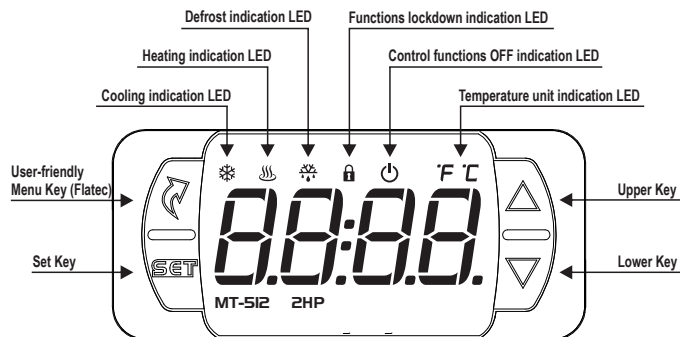

## 6. WIRING DIAGRAM

### 6.1. Identifications (see Images I to IV)

- Image I: MT-512E 2HP, supplied at 115 Vac.
- Image II: MT-512E 2HP, supplied at 230 Vac.
- Image III: MT-512EL 2HP, supplied at 12 Vac/dc.
- Image IV: MT-512EL 2HP, supplied at 24 Vac/dc.

### IMPORTANT

THE USE OF APPROPRIATE TOOLS IS ESSENTIAL TO AVOID DAMAGE IN THE CONNECTION AT INSTRUMENT TERMINALS:  
 ⊖ SCREWDRIVER SLOT 3/32" (2.4mm) FOR ADJUSTMENTS IN THE SIGNAL TERMINALS;  
 ⊕ SCREWDRIVER PHILLIPS #1 FOR ADJUSTMENTS IN THE POWER TERMINALS;

Image I: MT-512E 2HP - 115Vac

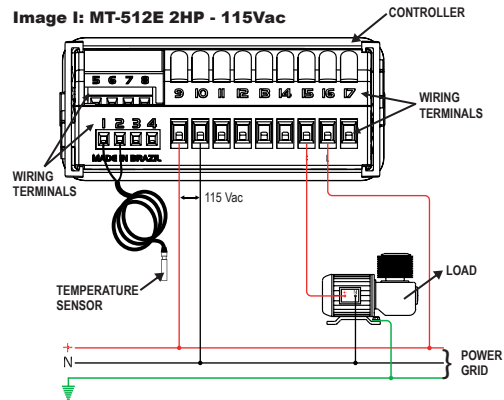

Image II: MT-512E 2HP - 230 Vac

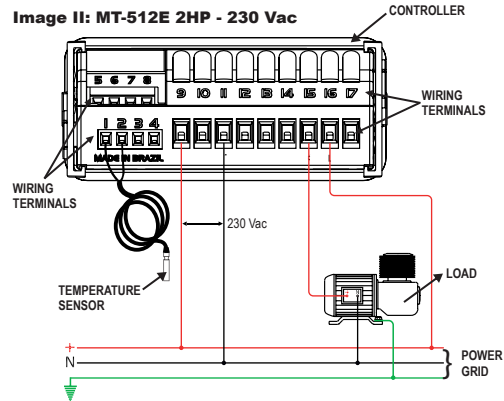
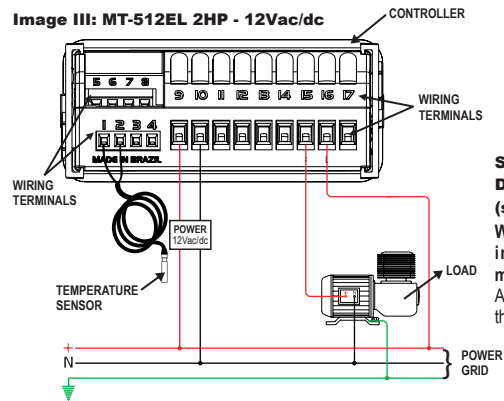

Image III: MT-512EL 2HP - 12Vac/dc



### Surge Protective Device (SPD) (sold separately)

Wiring diagram for installation of SPD in magnetic contactor. A1 and A2 are the terminals of the contactor coil.

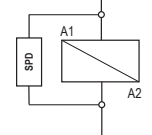
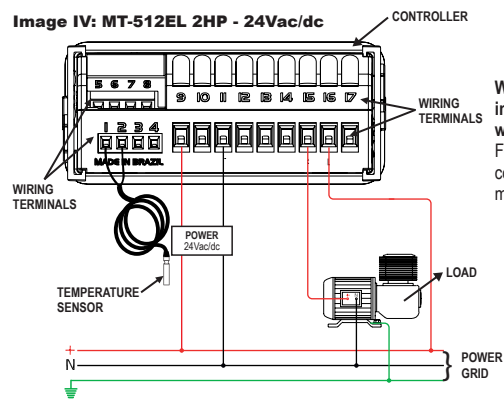
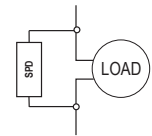

Image IV: MT-512EL 2HP - 24Vac/dc



### Wiring diagram for installation of SPD in line with loads

For direct drive take in to consideration the specified maximum current.



### 6.2. Temperature sensor connection

- Connect the sensor wires to terminals '1 and 2': the polarity is not relevant.
- Length of the sensor cables can be increased by user himself to up to 200 meters, using a PP 2x24 AWG cable.
- For immersion in water, use a thermowell (Image VI - item 12), available in the Full Gauge Controls product line (sold separately).

### 6.3. Controller power supply

Use the pins according to table below, considering the set version:

Pins	MT-512E 2HP	MT-512EL 2HP
9 and 10	115 Vac	12 Vac/dc
9 and 11	230 Vac	24 Vac/dc

### 6.4. Recommendations of IEC60364 standard

- Install overload protectors in the controller supply.
- Install transient suppressors – suppressor filter RC – in the circuit to increase the service life of the controller relay. See connection instructions of the filter on the previous page.
- The sensor cables may be together, but not in the same conduit where the power supply of the controller and/or of the loads passes through.

## 7. FASTENING PROCEDURE

- Cut out the panel plate (Image V - item 12) where the controller shall be fastened, with sizes  $X = 71 \pm 0.5$  mm and  $Y = 29 \pm 0.5$  mm;
- Remove side locks (Image VII - item 12): to do that, compress the central elliptical part (with the Full Gauge Controls logo) and displace the locks backwards;
- Introduce the controller in the notch made on the panel, inwards;
- Place the locks again and then displace them until they compress into the panel, fastening the controller to the housing (see arrow indication in Image VII - item 12);
- Perform the electric installation as described in item 6;
- Adjust the parameters as described in item 8.

**ATTENTION:** for installations requiring liquid tight sealing, the notch sizes for the controller installation should be no more than 70.5x29mm. The side locks should be fastened so that they press the sealing rubber avoiding infiltration between the notch and the controller.

Protector vinyl - Image VIII (item 12)

It protects the controller when installed at a site subject to water spills, such as refrigerated counters. This adhesive vinyl is supplied with the instrument in the package.

**IMPORTANT:** Make the application only after completing the electrical connections.

- Retreat the side locks (Image VII - item 12);
- Remove the protective film from the adhesive vinyl face;
- Apply the vinyl over the entire upper part, bending the flaps, as indicated by the arrows - Image VIII (item 12);
- Reinstall the locks.

**NOTE:** The vinyl is transparent, allowing visualization of the wiring system of the instrument.

## 8. ADJUSTMENT OF THE SETPOINT AND PARAMETERS

### 8.1. Quick Access Menu Map

By pressing  $\square$  (Fplate), it is possible to navigate through the function menus. For more details, see chapter 8.3. See the functions map below:

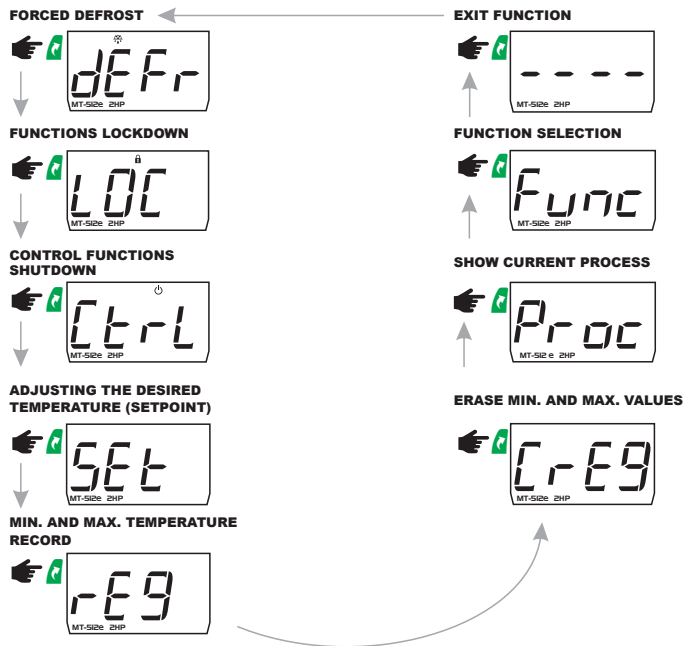

### 8.2. Quick access keys map

When the controller is on temperature display mode, the following keys serve as a shortcut for the following functions:

	Hold down for 5 seconds: turn on/turn off the control functions.
	Hold down for 2 seconds: setpoint adjustment.
	Quick touch: current process display.
	Quick touch: maximum and minimum temperatures display (record).
	Pressed simultaneously: access to functions selection.

## 8.3. Basic operations

### 8.3.1. Adjustment of the Setpoint (desired temperature)

Press the key  $\square$  for 2 seconds until the message [SEt.] is displayed. Releasing the key will display the control temperature currently adjusted.

Use the keys  $\uparrow$  or  $\downarrow$  to modify the value and press  $\square$  for recording.

The desired temperature can also be changed by the facilitated menu (see map in item 8.1) or by the function [F02] : see item 8.4.2.

### 8.3.2. Manual Defrost

Manual defrost is activated by the facilitated menu. Press the key  $\square$  (short touch) until the message [dEFr.] (led  $\odot$  flashing) is displayed. Then press the key  $\square$  (short touch) to select. The message [dEFr.] [On.] (led  $\odot$  on) will be displayed.

In order to disable the manual defrost, press the key  $\square$  (short touch) until the message [dEFr.] (led  $\odot$  flashing) is displayed. Press the key  $\square$  (short touch) to select. The message [dEFr.] [OFF.] (led  $\odot$  off) will be displayed.

The manual defrost process also can be activated/deactivated by pressing the key  $\square$  for 4 seconds.



### 8.3.3. Function blocking

The activation of function blocking feature allows safety against undue alterations of the Setpoint and of the other parameters. In this condition, when trying to alter the values, the message [L.D.C.] will be displayed. However, the parameters can still be seen.

In order to perform the function blocking the parameter [F02] (Time for function blocking) must be set with the value above 14 (if below 15, [no.] will be displayed, which means function blocking is prevented).

With the key  $\square$  (short touch), select  $\square$ , then press  $\square$  (short touch), and keep pressing the key  $\square$  until the message [L.D.C.] is displayed.

Releasing the key will display the message [On.]



To unblock, turn the controller off, and then turn it on again with the key  $\square$  pressed. Keep the key pressed until the message [L.D.C.] is displayed. After releasing it, the message [OFF.] will be displayed.

### 8.3.4. Turning the Control Functions Off

Turning the control functions off will make the controller start operating just as a temperature indicator and the output relay remains off.

How the operation of turning the control functions off is made shall depend on the parameter [F2 i] setting (Turning the control functions off).

With the key  $\square$  (short touch), select  $\square$  and then press  $\square$  (short touch) to confirm.

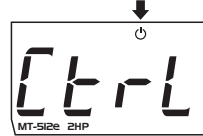

Soon the message [Ctrl.] [OFF.] will be displayed and the temperature display will be alternated with the message [OFF.]

For turning the control functions on again, apply the same procedure used for turning off, selecting with the key  $\square$  (short touch),  $\square$ . When pressing the key  $\square$  the message [Ctrl.] [On.] will be displayed.

Also is possible turn on/ turn off the control functions by pressing the key  $\square$  for 5 seconds.

**NOTE:** When turning the control functions on again, the MT-512E 2HP will continue to respect the functions [F09] (Minimum output-off time) and [F12] (initial status when powering the instrument on).

### 8.3.5. Viewing the Processes

For viewing the status and the time elapsed, press  $\square$  (short touch).

The controller will display the current process, which may be with the following messages:

- [---] Control off
- [dEL.] Initial delay
- [rEFr.] Refrigeration
- [HEt.] Heating
- [dEFr.] Defrost

### 8.3.6. Minimum and Maximum Temperature Recording

Pressing the key  $\square$  or also by the facilitated menu (see map in item 8.1) the message [rEg.] will be displayed, and then the minimum and maximum temperatures will be recorded.

To delete the current minimum and maximum values, press the key  $\square$  (short touch) until the message [CrEg.] is displayed. Press the key  $\square$  to confirm.

### 8.3.7. Selection of Temperature Measurement Unit

For defining the unit with which the instrument will operate enter the function [F0 i] with access code 231 and press the key  $\square$ . Then, select the unit by pressing the keys  $\uparrow$  or  $\downarrow$ : the units [°C.] or [°F.] will be displayed. Press the key  $\square$  to confirm the selection. The indication corresponding to the unit (C or F) will be displayed.

**NOTE:** Every time the unit is changed, the parameters should be reset, since they assume the 'standard' values of the parameter's table.

## 8.4. Advanced operations

- **NOTE 1:** The graph below illustrates the meaning of temperature-related parameters.

- **NOTE 2:** The access to all parameters is protected by the access code: see item 8.4.3 (F01).

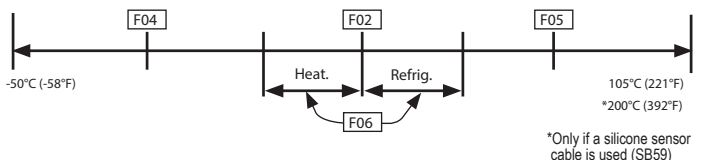

### 8.4.1. Adjustment of the parameters

Access the function [F0 i] by pressing simultaneously the keys **▲** and **▼** or by the facilitated menu.

When [F0 i] is displayed, press the key **↵** (short touch).

Use the keys **▲** or **▼** to enter with the access code [i23] and, when ready, press **↵**.

Use the keys **▲** or **▼** to access the desired function.

After selecting the function, press the key **↵** (short touch), to view the value set for that function. Use the keys **▲** or **▼** to alter the value and press **↵** to memorize the value set and return to the function menu.

To exit the menu and return to the normal operation (temperature indication), press **↵** (long touch) until [---] is displayed.

**NOTE 1:** If function blocking is active, pressing the keys **▲** or **▼**, the controller will display the message [LDC.] and parameters will not be allowed to be altered.

**NOTE 2:** 15 seconds after supplying the access code and/or after setting a parameter, with no touches in the buttons, the controller returns to the operation mode and the access code will have to be entered again in function F01.

### 8.4.2. Parameters table

Fun	Description	CELSIUS				FAHRENHEIT			
		Min	Max	Unit	Standard	Min	Max	Unit	Standard
[F01]	Access codes	-	-	-	-	-	-	-	-
[F02]	Desired temperature (Setpoint)*	-50	200	°C	4	-58	392	°F	39
[F03]	Indication shifting (Offset)	-5.0	5.0	°C	0	-9	9	°F	0
[F04]	Minimum setpoint allowed to the user	-50	200	°C	-50	-58	392	°F	-58
[F05]	Maximum setpoint allowed to the user	-50	200	°C	75	-58	392	°F	167
[F06]	Control differential (hysteresis)	0.1	20.0	°C	1.0	1	36	°F	1
[F07]	Operation mode	0-cool.	1-heat.	-	0-cool.	0-cool.	1-heat.	-	0-cool.
[F08]	Minimum output-on time	no	999	sec	20	no	999	sec	20
[F09]	Minimum output-off time	no	999	sec	20	no	999	sec	20
[F10]	Refrigeration time (defrost interval)	1	999	min	240	1	999	min	240
[F11]	Defrost time	no	999	min	30	no	999	min	30
[F12]	Initial state when powering the instrument on	0-cool.	1-defr.	-	0-cool.	0-cool.	1-defr.	-	0-cool.
[F13]	Locked temperature indication during defrost	no	yes.	-	no	no	yes	-	no
[F14]	Instrument powering-on delay	no	240	min	no	no	240	min	no
[F15]	Additional time to the end of the first cycle	no	240	min	no	no	240	min	no
[F16]	Compressor situation with damaged sensor	0	2	-	0	0	2	-	0
[F17]	Compressor-on time in the event of error	1	999	min	15	1	999	min	15
[F18]	Compressor-off time in the event of error	1	999	min	15	1	999	min	15
[F19]	Digital filter intensity	no	9	-	no	no	9	-	no
[F20]	Function blocking time	no	60	sec	no	no	60	sec	no
[F21]	Turning the control functions off	no	4	-	no	no	4	-	no

\*The minimum and maximum values depend on the values configured in [F04] and [F05]. Legend: [yE5] = yes [no.] = no

### 8.4.3. Parameters description

#### F01 - Access codes:

The **MT-Size ZHP** is provided with two different access codes:

[i23] Allows changing the advanced parameters.

[23 i] Allows selecting the temperature unit: Celsius or Fahrenheit.

#### F02 - Desired temperature (Setpoint):

This is the reference value for temperature control, i.e., the desired temperature to maintain in the controlled environment, or the temperature at which the load supply output is turned off.

#### F03 - Indication shifting (Offset):

It allows the offsetting of any temperature deviations in view of the sensor replacement or alteration in the cable length.

#### F04 - Minimum setpoint allowed to the user:

Avoid selection, by mistake, of extremely low setpoint temperatures.

#### F05 - Maximum setpoint allowed to the user:

Avoid selection, by mistake, of extremely high setpoint temperatures.

#### F06 - Control differential (hysteresis):

This is the difference in temperature (hysteresis) between turning the refrigeration (or heating) ON and OFF.

#### Examples:

- **Refrigeration:** One wants to control the temperature at 4.0 °C with a differential of 1.0 °C: the output will be turned off at 4.0 °C and turned on again at 5.0 °C (4.0 + 1.0).

- **Heating:** One wants to control the temperature at 30.0 °C with a differential of 5.0 °C: the output will be turned off at 30.0 °C and turned on again at 25.0 °C (30.0 - 5.0).

**NOTE:** Using very low hysteresis values will cause a high frequency at the on and off action of the relay, reducing its service life.

#### F07 - Operation mode:

Allows selecting the controller operation mode:

[0] Refrigeration

[1] Heating

#### F08 - Minimum output-on time:

This is the minimum time in which the load will remain on, i.e., the interval between the last start and the next stop.

#### F09 - Minimum output-off time:

This is the minimum time in which the load will remain off, i.e., the interval between the last stop and the next start. In the case of refrigeration, one relieves the discharge pressure, increasing the compressor service life.

#### F10 - Refrigeration time (defrost interval):

Corresponds to the time in which the controller will operate in refrigeration. After this period, the controller starts the defrost process.

#### F11 - Defrost time:

This is the defrost duration time. Within this period, the relay will remain off. After this period, the controller will return to the refrigerated state.

#### F12 - Initial state when powering the instrument on:

When selecting the option [0] (Refrigeration), the controller starts the refrigeration.

When selecting the option [1] (Defrost), the system will perform defrost when the controller is powered on. Duration of defrost will be according to parameter F11.

#### F13 - Locked temperature indication during defrost:

Select the acronym [no.] for not locking the indication and [yE5] to lock it.

With the indication locked, this will only be released at the next refrigeration cycle after the temperature reaches again this 'locked' value or after 15 minutes in refrigeration (as a safety measure).

#### F14 - Instrument powering-on delay:

When the instrument is turned on, this may remain for a while with the control disabled, delaying the process start. Within this period, it works only as a temperature indicator. This delay may occur with the compressor or with defrost (when defrost is set at the start).

The goal is to avoid power demand peaks upon return thereof after fault, when several pieces of equipment are connected in the same electric grid. The delays should be adjusted at different values for each piece of equipment.

**NOTE:** After the end of delay, the 'minimum output-off time' count is started (if it has been set in parameter F09).

#### F15 - Additional time to the end of the first cycle:

It is used to increase the working time only of the first refrigeration cycle, increasing the efficiency.

#### F16 - Compressor situation with damaged sensor:

If the temperature sensor is undergoing short circuit, turned off or is off the measuring range, the compressor assumes the state set in this parameter:

[0] Compressor off.

[1] Compressor on.

[2] Cycling according to times defined in F17 and F18.

**NOTE:** If it is in heating mode, and with some error, the output will be turned off.

#### F17 - Compressor-on time in the event of error:

It defines the minimum time during which the compressor will remain on, if the sensor is off or outside the measuring range.

#### F18 - Compressor-off time in the event of error:

It defines the minimum time during which the compressor will remain off, if the sensor is off or outside the measuring range.

#### F19 - Digital filter intensity:

This filter has the purpose of simulating thermal mass increase in the sensor, thus increasing its response time (thermal inertia). The greater the value set in this function, the greater the sensor response delay will be.

#### F20 - Function blocking time:

This functionality being active, the setpoint and the other parameters will be protected against undue alterations, with only the setpoint and the parameters being visualized. In order to block the functions, please refer to item 8.3.3. Function blocking.

#### F21 - Turning the control functions off:

Authorizes switching off the control functions (see item 8.3.4).

[no.] Disables the control functions shutdown.

[1] Enables activation/deactivation of the control functions only if the functions are unlocked.

[2] Enables activation/deactivation of the control functions even if the functions are locked.

[3] Enables activation/deactivation of the control functions only if the functions are unlocked.\*

[4] Enables activation/deactivation of the control functions even if the functions are locked.\*

\* When F21 is configured as 3 or 4 and the control functions shutdown is activated, the controller will turn off the display, keeping only the indication  light on.

If any key is touched the display turns on by 5 seconds, turning off again until a new key is touched.

## 9. DISPLAY SIGNALINGS

[Er 1]	Error in sensor: Sensor disconnected or damaged.
[OFF.]	Control functions off.
[dEFC.] [0n.]	Manual activation of the defrost process.
[dEFC.] [OFF.]	Manual activation of the cooling process.
[LDC.] [0n.]	Temper proof function.
[LDC.] [OFF.]	Unlocking of functions.
[PPPP]	Reconfigure the values of the functions.

## 10. GLOSSARY OF ACRONYMS

- °C: Temperature in Celsius degrees.

- °F: Temperature in Fahrenheit degrees.

- Defr: Defrost.

- LOC: Blocked.

- No: No.

- OFF: Turned off/disabled.

- ON: Turned on, enabled.

- Refr: Refrigeration.

- SET (as in "Setting") (setting or configuration).

- Vac: Electrical voltage (volts) of alternating current.

- Vdc: Electrical voltage (volts) of direct current.

- Yes: Yes.

**11. OPTIONAL ITEMS - Sold Separately**

**Ecase protective cover**

It is recommended for the Evolution line, keeps water from entering the back part of the instrument. It also protects the product when the installation site is washed.

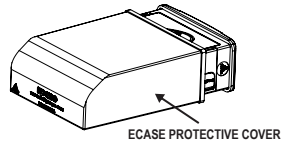

ECASE PROTECTIVE COVER

**Extended frame**

It allows the installation of Evolution line controllers with sizes 76 x 34 x 77 mm in various situations, since it does not require precision in the notch of the instrument fitting panel.

The frame integrates two switches of 10 Amperes that may be used to actuate interior light, air curtain, fan, and others.

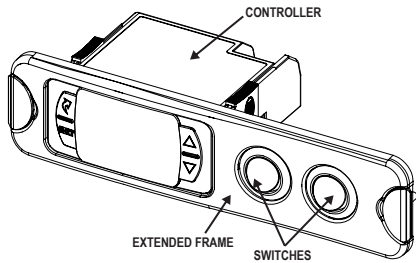

EXTENDED FRAME  
CONTROLLER  
SWITCHES

**EasyProg - version 2 or higher**

It is an accessory that has as its main function to store the parameters of the controllers. At any time, you can load new parameters of a controller and unload them on a production line (of the same controller), for example. It has three types of connections to load or unload the parameters:

- **Serial RS-485:** It connects via RS-485 network to the controller (only for controllers that have RS-485).
- **USB:** it can be connected to the computer via the USB port, using Sitrad's Recipe Editor.
- **Serial TTL:** The controller can be connected directly to **EasyProg** by the TTL Serial connection.

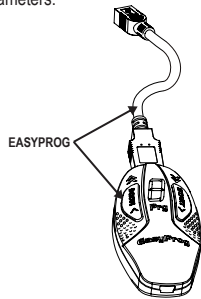

EASYPROG

**12. ANNEXES - Reference Images**

**Image V**

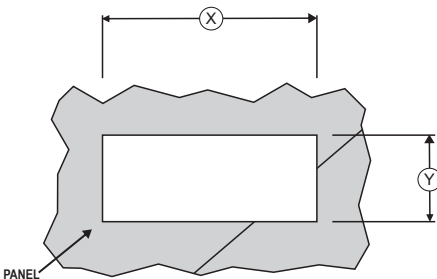

**Image VII**

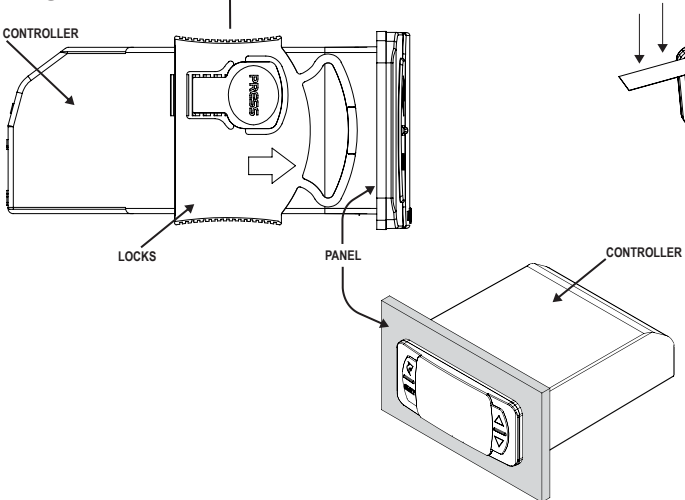

**Image VI**

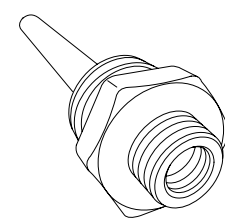

**Image VIII**

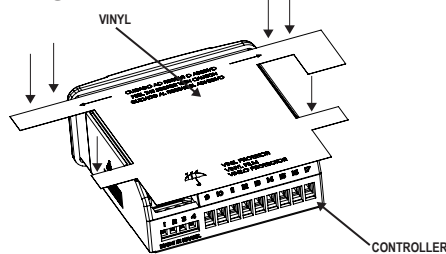

Customer Service (Americas) +1.800.304.6563  
 Customer Service Facsimile +1.800.426.0804  
 HVACCustomerService@robertshaw.com

For Technical Service  
 Telephone +1.877.917.6643

Ranco® is a trademark of Robertshaw, its subsidiaries and/or affiliated companies. All other brands mentioned may be the trademarks of their respective owners.

www.robertshaw.com  
 ©2020 Robertshaw  
 07/20 – 352-00297-001